

CX 8 ANCHOR

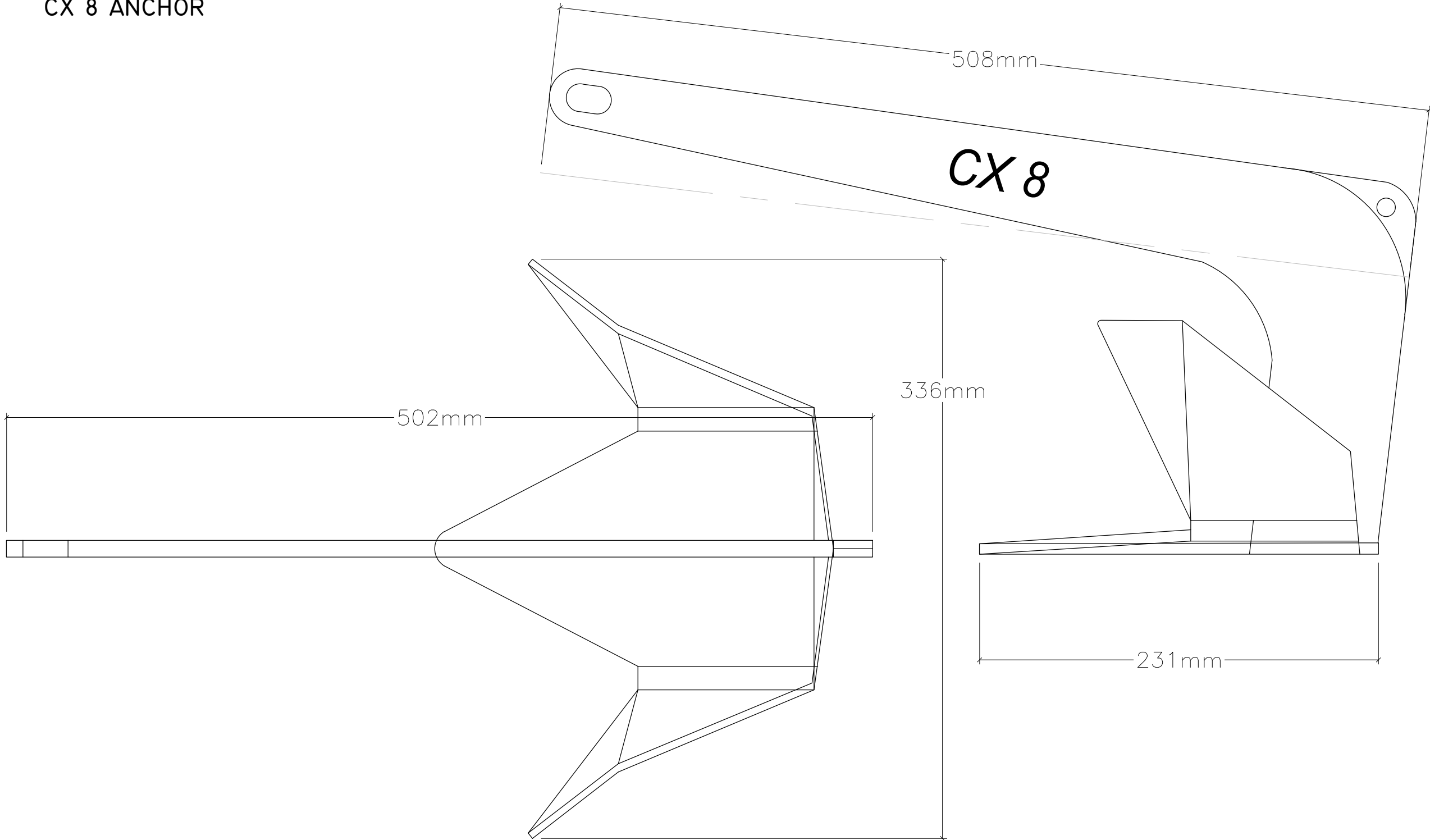

NOTE: ALL DIMENSIONS ARE IN MILLIMETERS



SIZE B	CX 8 ANCHOR ADDRESS		DWG DATE 07/20/2020	
	PROJECT MANAGER:	DRAWN BY: JDN	SCALE: N.T.S.	SHEET 1 OF 1